



INXX II bath mixer

With its durable matt black finish and hand shower with a large, round nozzle, makes this mixer looks great and gives a truly relaxing baths. The INXX II collection offers a world-class water experience with constant temperature, high comfort and effective scald protection. The mixer has been tested and approved according to current building regulations and is energy-efficient, which means it reduces water and energy use without compromising on comfort.

About the collection

INXX II is an elegant, timeless collection in a palette of carefully selected colours. Offering a combination of high quality, sober design and outstanding comfort, this is the ultimate collection.

Article number: 270050.12 **RSK:** 8245099 **Flow 3 bar:** 7.6 l/m

Description: Matte black, 160 c/c

Unique characteristics

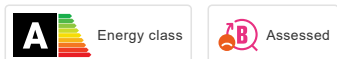

Backflow protection unit type **EB**

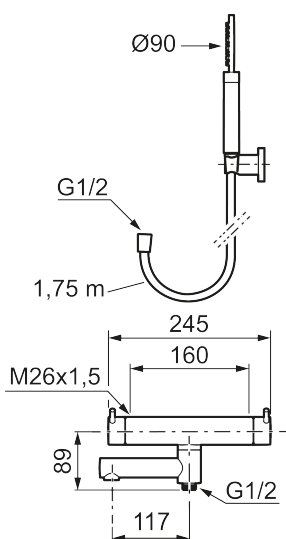

- With hand shower, holder and hose in metal, PVC- and BPA-free inner hose
- Swivel spout with built-in diverter
- Temperature- and pressure-balanced shower mixer that reacts quickly to changes and maintains an even water temperature
- Temperature handle with safety stop at 38°C
- Water-saving eco function on the flow control knob
- Approved non-return valves, EN-Standard EN1717

PRODUCT DESCRIPTION

INXX II bath mixer

With its durable matt black finish and hand shower with a large, round nozzle, makes this mixer looks great and gives a truly relaxing baths. The INXX II collection offers a world-class water experience with constant temperature, high comfort and effective scald protection. The mixer has been tested and approved according to current building regulations and is energy-efficient, which means it reduces water and energy use without compromising on comfort.

About the collection

INXX II is an elegant, timeless collection in a palette of carefully selected colours. Offering a combination of high quality, sober design and outstanding comfort, this is the ultimate collection.

Article number: 270050.12

RSK: 8245099

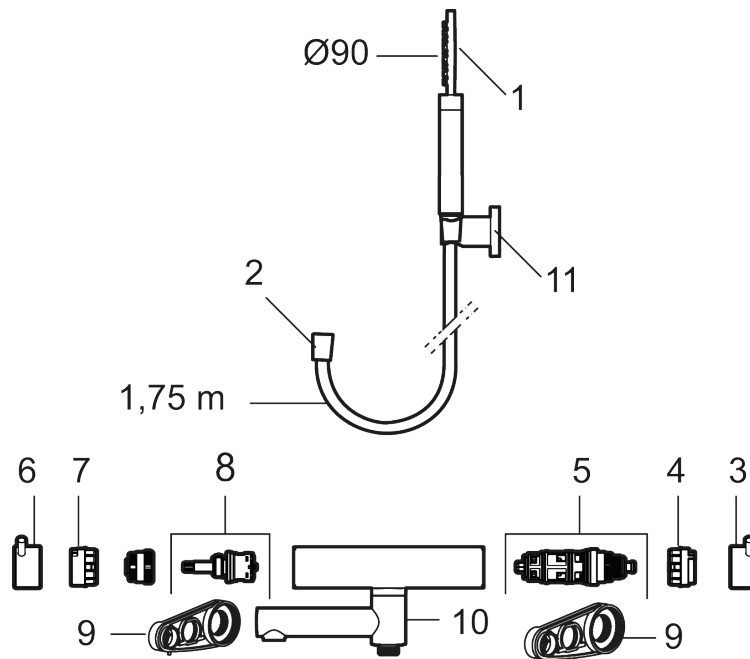

Sparepartlist

NO.	ART NO.	RSK	DESCRIPTION
1	S600290	8233191	Hand shower, chrome
1	S600290.12	8233192	Hand shower, matte black
1	S600290.60	8233193	Hand shower, polished brass PVD
1	S600290.62	8233194	Hand shower, brused brass PVD
2	S600109	8252036	Shower hose, chrome
2	S600109.12	8236624	Shower hose in metal, 1750 mm, matte black
2	S600109.60	8236627	Shower hose in metal, 1750 mm, polished brass PVD

NO.	ART NO.	RSK	DESCRIPTION
2	S600109.62	8236628	Shower hose in metal, 1750 mm, brused brass PVD
3	409710.AE	8218902	Temperature handle, chrome
3	409710.12AE	8218903	Temperature handle, matte black
3	409710.60AE	8218906	Temperature handle, polished brass PVD
3	409710.62AE	8218907	Temperature handle, brused brass PVD
4	S600023	8439703	Stop ring
5	S600019	8439702	Thermostatic cartridge, complete, with service tool
6	409711.AE	8218901	Temperature handle, chrome
6	409711.12AE	8218908	Temperature handle, matte black
6	409711.60AE	8218911	Temperature handle, polished brass PVD
6	409711.62AE	8218912	Temperature handle, brused brass PVD
7	S600024	8439705	Stop ring
8	S600021	8441463	Reversible headwork 22 l/min, with service tool
8	S600270	8387233	Reversible headwork 22 l/min
9	S600298	3870203	Service tool
10	S600161	8440630	Swivel spout, for coversion of shower mixer to bath/shower mixer, chrome
10	S600161.12	8440631	Swivel spout, for coversion of shower mixer to bath/shower mixer, matte black
10	S600161.60	8440634	Swivel spout, for coversion of shower mixer to bath/shower mixer, polished brass PVD
10	S600161.62	8440635	Swivel spout, for coversion of shower mixer to bath/shower mixer, brushed brass PVD