



MORA CLASSIC basin mixer

Mora Classic is an exclusive range of taps with solid, rounded lines that embrace the design ideals of the past. All the parts are made of metal with genuine Mora quality. A Mora Classic basin mixer adds a distinctive touch and feel to your whole bathroom interior. All the mixers have a ceramic seal as standard. This is modern technology fused with classic style at its best.

Article number: 700741 Flow 3 bar: 6.0 l/m

Description: Chrome

- With pop-up waste
- Hole diameter Ø33-37mm

Unique characteristics

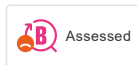

Backflow protection unit type

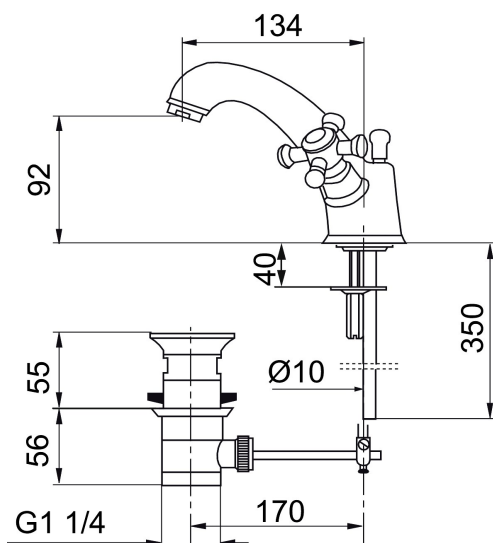

PRODUCT DESCRIPTION

MORA CLASSIC basin mixer

Mora Classic is an exclusive range of taps with solid, rounded lines that embrace the design ideals of the past. All the parts are made of metal with genuine Mora quality. A Mora Classic basin mixer adds a distinctive touch and feel to your whole bathroom interior. All the mixers have a ceramic seal as standard. This is modern technology fused with classic style at its best.

Article number: 700741

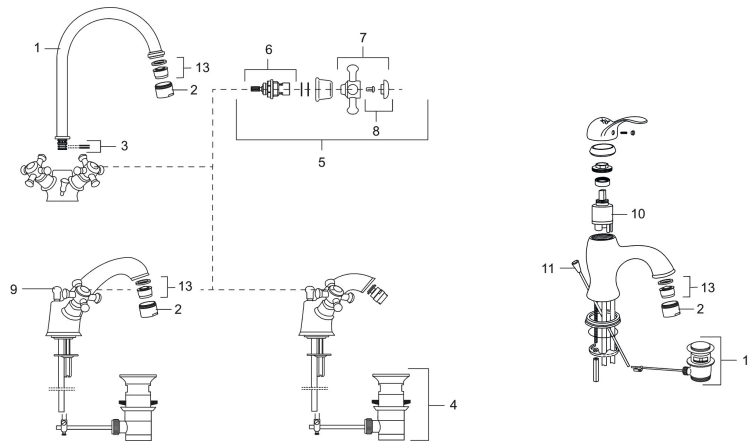

Sparepartlist

NO.	ART NO.	RSK	DESCRIPTION
1	708139.AE		Swivel spout for basin and kitchen
2	131413.AE	8281511	Housing M24 ext., 13 mm, chrome
3	708140.AE	8345168	Gasket kit for swivel spout
4	520300		Pop-up waste, Mora Classic, complete with lifting rod
5	708146.AE	8345170	Headwork, complete with handle HW/CW
6	719109.AE	8345169	Headwork 1/2", without handle
7	708137.AE		Handle, complete with screw and cover plate
8	708135.AE		Screw and cover plate (CW+HW), chrome
9	719164.AE		Lifting rod
10	708295.AE	8345131	Ceramic cartridge
11	529116.AE	8572633	Lifting rod, L=370 mm
12	520294	8572612	Pop-up waste, without lifting rod
13	131398.AE	8281493	Aerator insert, 9–11 l/min at 300 kPa